

Nord-Lock washers

Product information



The proven original



Since the Nord-Lock Group began operations in 1982 we have focused on providing the world's most effective bolt securing system. Our products are based on leading wedge-locking technology and are recognized for their ability to safely secure bolted joints exposed to severe vibration and dynamic loads.

When you choose Nord-Lock you do not only choose a supplier or a manufacturer, you also benefit from a partnership with an expert in bolted joint technology. Our global team of sales engineers work with our clients to solve bolt securing problems in the most demanding applications.

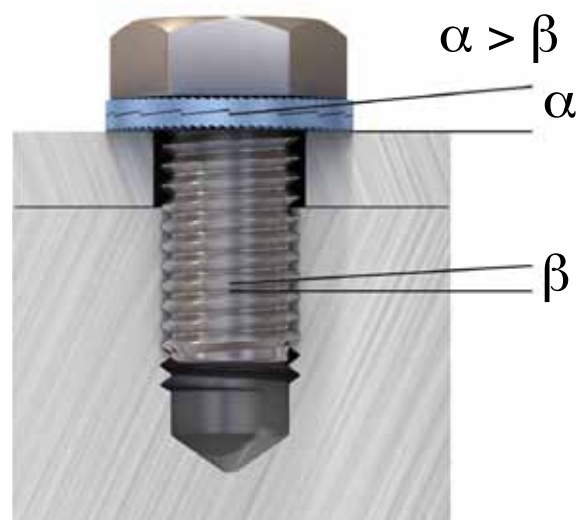

Nord-Lock wedge-locking technology



Nord-Lock wedge-locking products are the optimum choice for critical bolted joints.

Nord-Lock washers secure bolted joints with tension instead of friction. The system is comprised of a pair of washers that has cams on one side and radial teeth on the opposite side. Since the cam angle ' α ' is greater than the thread pitch ' β ' a wedge effect is created by the cams, preventing the bolt from rotating loose.



Over the years, Nord-Lock washers have been rigorously tested and approved by independent institutes as well as certification authorities.

Proven in Junker vibration test

The Junker test, according to DIN 65151, is considered the most severe vibration test for bolted connections. During the test, the joint is exposed to transverse movements underneath the bolt head / nut, while the clamping force is continuously measured.

Vibration test

Bolt M8 (8.8) with clamp length 25 mm

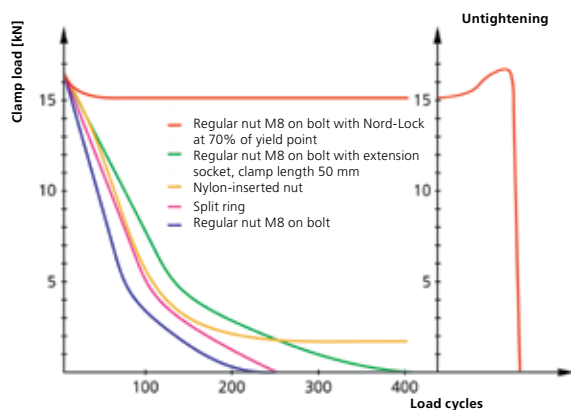

Fig 1: The Junker test shows that Nord-Lock washers safely secured the bolted connection; only a limited amount of tension is initially lost due to normal settlements. The wedge-locking function is verified through the clear increase in tension during untightening. All other bolt locking methods in the test failed to prevent loosening of the joint.

Nord-Lock washers are proven as a safe bolt securing system according to DIN 65151 tests performed by the independent research organisations IMA and CETIM. In addition, Nord-Lock personnel performs over 10,000 live Junker vibration tests around the globe every year. Would you like to see a live demonstration? Find your nearest representative through www.nord-lock.com/contact

Proven according to NASM impact & vibration test

The National Aerospace test, according to NASM 1312-7, is a test method originally developed by the U.S. military to test bolted connections' resilience against impact and vibration.

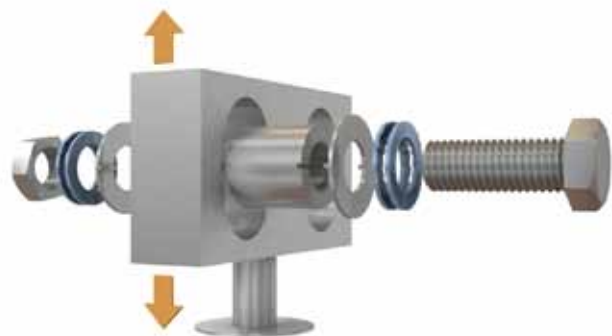

Fig 2: Drawing of the test rig. The assembled parts are vibrated vertically and the joints are subjected to two impacts per cycle. The impacts are parallel to the bolt. The arrow displays the direction of vibration during the test. After testing, the fasteners are inspected for rotation.

Nord-Lock washers are proven as a safe bolt securing system according to NASM 1312-7 tests performed by the independent organisation Det Norske Veritas (DNV). If you wish to perform your own real-life testing and evaluation of Nord-Lock washers for your application, you can order samples through www.nord-lock.com/contact

Proven and certified by TÜV

Nord-Lock washers have been certified for safety and quality by TÜV, a leading international institute in quality and safety certification. In a two-step process, TÜV monitored and successfully approved both Nord-Lock washers and Nord-Lock's production facilities.



Widely used & globally approved



Nord-Lock washers are a high end products with documented success in many industries. Our washers are approved by several industry standards and specified by numerous international companies.

Industries where Nord-Lock washers are used

Nord-Lock washers are used in industries such as: energy, transportation, offshore, mining and quarrying, construction and bridge building, manufacturing and processing, ship building, forestry and agriculture, heavy vehicles, and military. The number of industries that use Nord-Lock washers are continuously growing.

Often joints do not start to loosen until an application is in regular use, therefore Nord-Lock washers are commonly retrofitted during maintenance, repair and overhaul procedures.

Certificates & approvals

The most prominent of our certificates are:

- AbP (Allgemein bauaufsichtliches Prüfzeugnis)
- DIBt (Deutsches Institut für Bautechnik)
- DNV (Det Norske Veritas)
- EBA (Eisenbahn-Bundesamt)
- TÜV (Technischer Überwachungs-Verein)



Quality & environmental assurance

- ISO 9001
- ISO 14001
- Licenced by Dörken to perform Delta Protekt® surface coating in-house
- RoHs, ELV and Reach compliant
- Full traceability

For more information or a complete list of certificates and approvals, please visit our website or contact your nearest Nord-Lock representative.

Traceability

Nord-Lock washers are rigorously tested in all steps of production to verify that the quality requirements are met. Each batch is assigned a control number which ensures full traceability and confirms that the washer is a genuine Nord-Lock article. The control number is printed on the package as well as on every washer pair, enabling full traceability down to first assembly – even when using bin systems for fastener supply.



In 2011 we began to laser mark our products with the Nord-Lock brand name, the control number and a type code for increased traceability and to facilitate authentication.

Laser marking, type code table

Washer type	Code
Steel, Delta Protekt® coating	fIZn
Stainless steel	SS
254 SMO®	254
INCONEL® / HASTELLOY® C-276	276
INCONEL® 718	718

The key to efficient & secure operations



Nord-Lock washers provide more than just a safe locking function, using our washers also improves the general performance of a bolted joint.

Product benefits

- Maintains high clamp load and thereby ensures the function of the joint
- Quick and easy to install and remove with standard tools
- Locking function not affected by lubrication
- Defined and uniform friction conditions which result in a more accurate preload
- Same temperature characteristics as standard bolt / nut
- Reusable – in addition, Nord-Lock washers do not affect the reusability of fasteners
- The washers are hardened and can support and distribute great loads
- Washers with enlarged outer diameter available for flanged bolts / nuts
- High corrosion resistance
- Can be used with fasteners up to grade 12.9 (ASTM A574)
- Reliable locking, even for joints with short clamp length
- Secures fasteners at both high and low preloads
- No retightening needed
- Verifiable locking function
- Elegant solution and problem solving – modern engineering

More than a physical product

Nord-Lock offers more than just secure bolted joints. When designing an application, it is important to consider the result it will generate throughout the entire lifespan. When using Nord-Lock products you also benefit from our experience and knowledge. We guide you towards the most beneficial and effective bolt design.

Life Cycle Profitability

Over the operational life cycle, Nord-Lock products give increased operational reliability and lower maintenance costs while significantly reducing the risks of production stops, accidents and warranty claims. We help you examine all cost factors related to bolted joints.

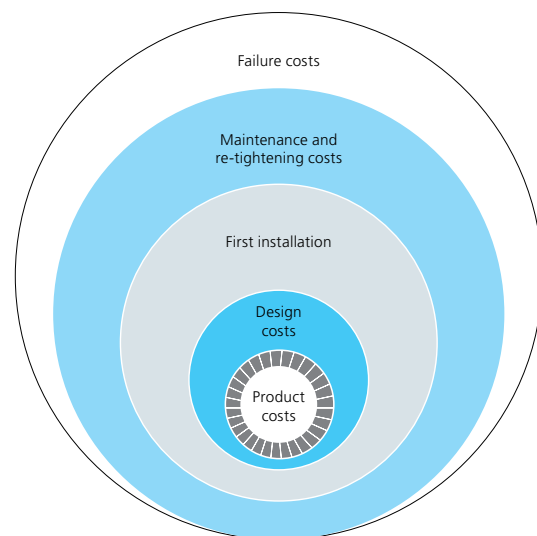

Nord-Lock products can help you increase your profitability by considering the complete life cycle cost for bolt securing.

Technical Center

Our skilled and innovative staff is available to help, review and discuss your applications in order to optimize the design of your bolted connections. Many companies take advantage of the customized tests or joint calculations we offer in our in-house laboratories located in Europe, North America and Asia. In addition, we offer on-site and remote product training.

Using Nord-Lock washers



Nord-Lock washers are easy and effective to use while ensuring structural security for applications exposed to vibration and dynamic loads.

Installing the washers

The pre-assembled washers are installed in pairs, cam face to cam face. Nord-Lock recommends lubrication when possible.

Tightening

Tighten Nord-Lock washers with standard tools according to the guidelines (on page 9-11). Tightening guidelines for other bolt grades are available through your Nord-Lock representative.

Untightening

Untightening Nord-Lock washers is as simple as tightening. Note that since the locking function is not based on increased friction, the untightening torque is generally lower than the tightening torque. Therefore it is not possible to measure off-torque as verification of locking function.

Reusing Nord-Lock

Nord-Lock washers can normally be reused. As with all fasteners, they should be inspected for wear before reassembly. Make sure that the washers are reinstalled correctly cam face to cam face. Nord-Lock recommends lubrication of fasteners before reuse in order to minimize changes in friction conditions.



Possible to verify the locking function

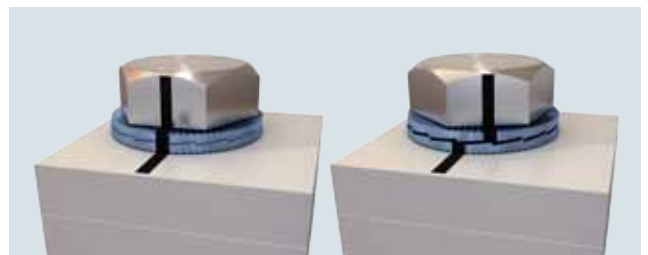

When untightening a bolt secured by Nord-Lock washers, check that sliding occurs between the cam faces.



After disassembly, impression marks must be visible on both the fastener and the contact surface.

When the two criteria above are met, you have verified the locking function of the Nord-Lock washers.

Utilize the advantages of lubrication

Nord-Lock recommends the use of a high quality, anti-seize lubricant as it improves the tightening results. It is especially beneficial for large sized bolts and stainless steel applications. The Nord-Lock wedge-locking function provides safe locking in both dry and lubricated conditions. Benefits of lubricated fasteners include:

- Improved reusability
- Reduced friction and deviation
- Facilitated assembly and disassembly
- Reduced torsion stress due to minimized thread friction
- Avoided galling and thread seizure
- Additional protection against corrosion



Nord-Lock washer material / type guide

Application parameter	Steel washers	Stainless steel (ss) washers	254 SMO® washers	INCONEL®/ HASTELLOY® C-276 washers	INCONEL® 718 washers
Steel type	EN 1.7182 or equivalent	EN 1.4404 or equivalent	EN 1.4547 or equivalent	EN 2.4819 or equivalent	EN 2.4667 or equivalent
Examples of applications	General steel applications	General stainless steel applications. Non chlorine / acid environments	General salt water applications, pumps, chloride applications, heat exchangers, nuclear, desalination, food processing & medical equipment	General acidic environments, process and chemical industry, evaporators, offshore downhole tooling	Applications with high temperatures, gas turbines, turbo charges, incinerators
Available for bolt sizes	M3-M130 (see page 8 for dimensions)	M3-M80 (see page 10 for dimensions)	M3-M39 (see page 11 for dimensions)	M3-M39 available upon request	M3-M39 available upon request
Washer types	Regular outer diameter (NL3-NL130) Enlarged outer diameter (NL3,5sp-NL36sp)	Regular outer diameter (NL3ss-NL80ss) Enlarged outer diameter (NL3,5spss-NL30spss)	Regular outer diameter (NL3ss-254-NL39ss-254) Enlarged outer diameter (NL3,5spss-254-NL27spss-254)	Regular outer diameter (NL3ss-276-NL39ss-276) Enlarged outer diameter (NL3,5spss-276-NL27spss-276)	Regular outer diameter (NL3ss-718-NL39ss-718) Enlarged outer diameter (NL3,5spss-718-NL27spss-718)
Treatment	Through hardened	Surface hardened	Surface hardened	Surface hardened	Surface hardened
Surface coating	Delta Protekt® base coat (KL100) and top coat (VH302GZ)				
Washer hardness*	≥ 465 HV1	≥ 520HV0,05	≥ 600HV0,05	≥ 520HV0,05	≥ 620HV0,05
Corrosion resistance	Minimum 600 hours in salt spray test (according to ISO9227)	PREN 27**	PREN 45**	PREN 68**	PREN 29**
Bolt grades	Up to 12.9	Up to A4-80	Up to A4-80	Up to A4-80	Up to A4-80
Temperature range***	-20°C to 200°C	-160°C to 500°C	-160°C to 500°C	-160°C to 500°C	-160°C to 700°C

* In order to assure the unique mechanical locking function of the Nord-Lock washers, the hardness of the mating surfaces must be lower than the hardness of the Nord-Lock washers (see table above).

** PREN (Pitting Resistance Equivalent Number) = %Cr + 3,3x%Mo + 16x%N. Figures in table valid for base material.

*** Temperature recommendations based on information from the raw material supplier. Locking function not affected within the specification.

Nord-Lock steel washers

EN 1.7182 or equivalent, zinc flake coating (Delta Protekt®), through hardened

Dimension chart

Washer size	Bolt size		ø [mm]	ø _o [mm]	Thickness T [mm]	Min. package [pairs]	Approx. weight kg / 100 pairs
	Metric	UNC					
NL3	M3	#5	3,4	7,0	1,8	200	0,03
NL3,5	M3,5	#6	3,9	7,6	1,8	200	0,04
NL3,5sp	M3,5	#6	3,9	9,0	1,8	200	0,06
NL4	M4	#8	4,4	7,6	1,8	200	0,04
NL4sp	M4	#8	4,4	9,0	1,8	200	0,06
NL5	M5	#10	5,4	9,0	1,8	200	0,05
NL5sp	M5	#10	5,4	10,8	1,8	200	0,11
NL6	M6		6,5	10,8	1,8	200	0,07
NL6sp	M6		6,5	13,5	2,5	200	0,20
NL1/4"		1/4"	7,2	11,5	1,8	200	0,08
NL1/4"sp		1/4"	7,2	13,5	2,5	200	0,18
NL8	M8	5/16"	8,7	13,5	2,5	200	0,15
NL8sp	M8	5/16"	8,7	16,6	2,5	200	0,28
NL3/8"		3/8"	10,3	16,6	2,5	200	0,23
NL3/8"sp		3/8"	10,3	21,0	2,5	200	0,48
NL10	M10		10,7	16,6	2,5	200	0,22
NL10sp	M10		10,7	21,0	2,5	200	0,47
NL11	M11	7/16"	11,4	18,5	2,5	200	0,29
NL12	M12		13,0	19,5	2,5	200	0,29
NL12sp	M12		13,0	25,4	3,4	100	0,93
NL1/2"		1/2"	13,5	19,5	2,5	200	0,27
NL1/2"sp		1/2"	13,5	25,4	3,4	100	0,90
NL14	M14	9/16"	15,2	23,0	3,4	100	0,56
NL14sp	M14	9/16"	15,2	30,7	3,4	100	1,41
NL16	M16	5/8"	17,0	25,4	3,4	100	0,67
NL16sp	M16	5/8"	17,0	30,7	3,4	100	1,28
NL18	M18		19,5	29,0	3,4	100	0,85
NL18sp	M18		19,5	34,5	3,4	100	1,58
NL3/4"		3/4"	20,0	30,7	3,4	100	1,05
NL3/4"sp		3/4"	20,0	39,0	3,4	100	2,20
NL20	M20		21,4	30,7	3,4	100	0,93
NL20sp	M20		21,4	39,0	3,4	100	2,03
NL22	M22	7/8"	23,4	34,5	3,4	100	1,29
NL22sp	M22	7/8"	23,4	42,0	4,6	50	3,31
NL24	M24		25,3	39,0	3,4	100	1,68
NL24sp	M24		25,3	48,5	4,6	50	4,51
NL1"		1"	27,9	39,0	3,4	100	1,53
NL1"sp		1"	27,9	48,5	4,6	50	4,20
NL27	M27		28,4	42,0	5,8	50	3,29
NL27sp	M27		28,4	48,5	5,8	25	5,39
NL30	M30	1 1/8"	31,4	47,0	5,8	50	4,20
NL30sp	M30	1 1/8"	31,4	58,5	6,6	25	8,96
NL33	M33	1 1/4"	34,4	48,5	5,8	25	3,97
NL33sp	M33	1 1/4"	34,4	58,5	6,6	25	8,31
NL36	M36	1 3/8"	37,4	55,0	5,8	25	5,59
NL36sp	M36	1 3/8"	37,4	63,0	6,6	25	9,15
NL39	M39	1 1/2"	40,4	58,5	5,8	25	6,28
NL42	M42		43,2	63,0	5,8	25	7,47
NL45	M45	1 3/4"	46,2	70,0	7,0	25	10,20
NL48	M48		49,6	75,0	7,0	25	12,00
NL52	M52	2"	53,6	80,0	7,0	25	13,00
NL56	M56	2 1/4"	59,1	85,0	7,0	10	13,50
NL60	M60		63,1	90,0	7,0	10	15,20
NL64	M64	2 1/2"	67,1	95,0	7,0	10	16,70
NL68	M68		71,1	100,0	9,5	1	28,19
NL72	M72		75,1	105,0	9,5	1	30,70
NL76	M76	3"	79,1	110,0	9,5	1	33,31
NL80	M80	3 1/8"	83,1	115,0	9,5	1	36,02
NL85	M85		88,1	120,0	9,5	1	37,84
NL90	M90		92,4	130,0	9,5	1	47,67
NL95	M95		97,4	135,0	9,5	1	49,81
NL100	M100	4"	103,4	145,0	9,5	1	58,91
NL105	M105		108,4	150,0	9,5	1	61,28
NL110	M110		113,4	155,0	9,5	1	63,65
NL115	M115		118,4	165,0	9,5	1	75,28
NL120	M120		123,4	170,0	9,5	1	77,94
NL125	M125		128,4	173,0	9,5	1	76,63
NL130	M130	5"	133,4	178,0	9,5	1	79,17

NL3-NL8
Ø_i±0,1 mm
NL10-NL42
Ø_i±0,2 mm
NL45-NL130
Ø_i+0,5 / -0,0 mm

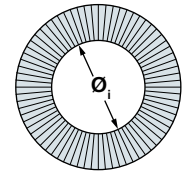

NL3-NL24
Ø_o±0,2 mm
NL27-NL42
Ø_o±0,3 mm
NL45-NL130
Ø_o+0,0 / -2,0 mm

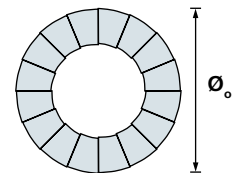

NL3-NL42
T±0,25 mm
NL45-NL130
T±0,75 mm

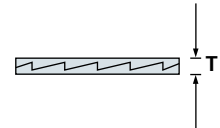

Note that washers with thickness 6,6 mm has a thickness tolerance +0,0 / -0,5 mm

- Please consult our website for current dimensions and 2D / 3D CAD models:
www.nord-lock.com/cad

Nord-Lock washers made of steel with zinc flake coating are standard stock items, yet subject to prior sale.

Torque guidelines

Nord-Lock steel washers with zinc flake coating (Delta Protokt®)

Nord-Lock steel washers with electro zinc plated **bolt grade 8.8**

Washer size	Bolt size	Pitch [mm]	Oil, $G_f=75\%$ $\mu_{th}=0,10, \mu_b=0,16$		Cu/C paste, $G_f=75\%$ $\mu_{th}=0,11, \mu_b=0,16$		Dry, $G_f=62\%$ $\mu_{th}=0,15, \mu_b=0,18$	
			Torque [Nm]	Clamp load [kN]	Torque [Nm]	Clamp load [kN]	Torque [Nm]	Clamp load [kN]
NL3	M3	0,5	1,3	2,4	2,1	2,4	1,3	2,0
NL4	M4	0,7	3,1	4,2	4,4	4,2	3,1	3,5
NL5	M5	0,8	6,0	6,8	8,0	6,8	6,0	5,6
NL6	M6	1,0	10,5	9,7	13,2	9,7	10,5	8,0
NL8	M8	1,25	25	18	30	18	25	15
NL10	M10	1,5	49	28	49	28	50	23
NL12	M12	1,75	85	40	83	40	85	33
NL14	M14	2,0	135	55	131	55	136	46
NL16	M16	2,0	205	75	197	75	208	62
NL18	M18	2,5	288	92	275	92	291	76
NL20	M20	2,5	402	118	382	118	408	97
NL22	M22	2,5	548	146	517	146	557	120
NL24	M24	3,0	693	169	652	169	703	140
NL27	M27	3,0	1010	221	945	221	1028	182
NL30	M30	3,5	1379	269	1286	269	1401	222
NL33	M33	3,5	1855	333	1722	333	1889	275
NL36	M36	4,0	2394	392	2219	392	2436	324
NL39	M39	4,0	3087	468	2852	468	3145	387
NL42	M42	4,5	3820	538	3525	538	3890	445

Cu/C paste = Copper/graphite paste (Molykote® 1000)

G_f = ratio of yield point

μ_{th} = thread friction

μ_b = washer friction

1 N = 0,225 lb

1 Nm = 0,738 ft-lb

Nord-Lock steel washers with non-plated **bolt grade 10.9**

Washer size	Bolt size	Pitch [mm]	Oil, $G_f=71\%$ $\mu_{th}=0,13, \mu_b=0,14$		Cu/C paste, $G_f=75\%$ $\mu_{th}=0,11, \mu_b=0,15$	
			Torque [Nm]	Clamp load [kN]	Torque [Nm]	Clamp load [kN]
NL3	M3	0,5	1,8	3,2	3,5	3,4
NL4	M4	0,7	4,1	5,6	7,0	5,9
NL5	M5	0,8	8,1	9,1	12,5	9,6
NL6	M6	1,0	14,1	12,9	20,1	13,6
NL8	M8	1,25	34	23	44	25
NL10	M10	1,5	67	37	73	39
NL12	M12	1,75	115	54	121	57
NL14	M14	2,0	183	74	188	78
NL16	M16	2,0	279	100	281	106
NL18	M18	2,5	391	123	388	130
NL20	M20	2,5	547	156	534	165
NL22	M22	2,5	745	194	719	205
NL24	M24	3,0	942	225	902	238
NL27	M27	3,0	1375	294	1297	310
NL30	M30	3,5	1875	358	1755	378
NL33	M33	3,5	2526	443	2340	468
NL36	M36	4,0	3259	522	3003	551
NL39	M39	4,0	4203	624	3845	659
NL42	M42	4,5	5202	716	4740	757

Nord-Lock steel washers with non-plated **bolt grade 12.9**

Washer size	Bolt size	Pitch [mm]	Oil, $G_f=71\%$ $\mu_{th}=0,13, \mu_b=0,12$		Cu/C paste, $G_f=75\%$ $\mu_{th}=0,11, \mu_b=0,15$	
			Torque [Nm]	Clamp load [kN]	Torque [Nm]	Clamp load [kN]
NL3	M3	0,5	2,0	3,9	3,8	4,1
NL4	M4	0,7	4,6	6,7	7,6	7,1
NL5	M5	0,8	9,1	10,9	13,6	11,5
NL6	M6	1,0	15,8	15,4	21,8	16,3
NL8	M8	1,25	38	28	47	30
NL10	M10	1,5	75	44	93	47
NL12	M12	1,75	128	65	151	68
NL14	M14	2,0	204	89	232	94
NL16	M16	2,0	311	120	342	127
NL18	M18	2,5	437	148	467	156
NL20	M20	2,5	610	188	638	198
NL22	M22	2,5	831	233	852	246
NL24	M24	3,0	1052	270	1064	286
NL27	M27	3,0	1533	352	1519	372
NL30	M30	3,5	2091	430	2042	454
NL33	M33	3,5	2815	532	2710	562
NL36	M36	4,0	3633	626	3463	662
NL39	M39	4,0	4683	748	4415	790
NL42	M42	4,5	5799	860	5429	908

Torque guidelines for other bolt grades are available through your local Nord-Lock representative.

Nord-Lock stainless steel washers

EN 1.4404 (AISI 316L) or equivalent, surface hardened

EN 1.4404 is an austenitic chromium-nickel stainless steel containing molybdenum. This stainless steel also has extra low carbon content in order to reduce the risk of chromium-carbide precipitation. EN 1.4404 is one of the most commonly used stainless steel grades and Nord-Lock washers made of EN 1.4404 are suitable for most applications where no chlorides or acids are present.

Dimension chart

Washer size	Bolt size		ϕ_i [mm]	ϕ_o [mm]	Thickness T [mm]	Min. package [pairs]	Approx. weight kg / 100 pairs
	Metric	UNC					
NL3ss	M3	#5	3,4	7,0	2,2	200	0,04
NL3,5ss	M3,5	#6	3,9	7,6	2,2	200	0,04
NL3,5spss	M3,5	#6	3,9	9,0	2,2	200	0,07
NL4ss	M4	#8	4,4	7,6	2,2	200	0,04
NL4spss	M4	#8	4,4	9,0	2,2	200	0,07
NL5ss	M5	#10	5,4	9,0	2,2	200	0,06
NL5spss	M5	#10	5,4	10,8	2,2	200	0,11
NL6ss	M6		6,5	10,8	2,2	200	0,09
NL6spss	M6		6,5	13,5	2,0	200	0,16
NL1/4"ss		1/4"	7,2	11,5	2,2	200	0,09
NL1/4"spss		1/4"	7,2	13,5	2,2	200	0,15
NL8ss	M8	5/16"	8,7	13,5	2,0	200	0,12
NL8spss	M8	5/16"	8,7	16,6	2,0	200	0,22
NL3/8"ss		3/8"	10,3	16,6	2,0	200	0,19
NL3/8"spss		3/8"	10,3	21,0	2,0	200	0,38
NL10ss	M10		10,7	16,6	2,0	200	0,18
NL10spss	M10		10,7	21,0	2,0	200	0,37
NL11ss	M11	7/16"	11,4	18,5	2,2	200	0,26
NL12ss	M12		13,0	19,5	2,0	200	0,23
NL12spss	M12		13,0	25,4	3,0	100	0,82
NL1/2"ss		1/2"	13,5	19,5	2,0	200	0,24
NL1/2"spss		1/2"	13,5	25,4	3,2	100	0,80
NL14ss	M14	9/16"	15,2	23,0	3,0	100	0,49
NL14spss	M14	9/16"	15,2	30,7	3,2	100	1,31
NL16ss	M16	5/8"	17,0	25,4	3,0	100	0,59
NL16spss	M16	5/8"	17,0	30,7	3,2	100	1,13
NL18ss	M18		19,5	29,0	3,2	100	0,80
NL18spss	M18		19,5	34,5	3,2	100	1,56
NL3/4"ss		3/4"	20,0	30,7	3,2	100	0,96
NL3/4"spss		3/4"	20,0	39,0	3,2	100	2,10
NL20ss	M20		21,4	30,7	3,0	100	0,82
NL20spss	M20		21,4	39,0	3,2	100	2,06
NL22ss	M22	7/8"	23,4	34,5	3,2	100	1,23
NL22spss	M22	7/8"	23,4	42,0	3,2	50	2,23
NL24ss	M24		25,3	39,0	3,2	100	1,52
NL24spss	M24		25,3	48,5	3,2	50	3,50
NL1"ss		1"	27,9	39,0	3,2	100	1,42
NL1"spss		1"	27,9	48,5	3,2	50	3,22
NL27ss	M27		28,4	42,0	6,8	50	3,45
NL27spss	M27		28,4	48,5	6,8	25	5,85
NL30ss	M30	1 1/8"	31,4	47,0	6,8	50	4,43
NL30spss	M30	1 1/8"	31,4	58,5	6,8	25	9,53
NL33ss	M33	1 1/4"	34,4	48,5	6,8	25	4,25
NL36ss	M36	1 3/8"	37,4	55,0	6,8	25	5,96
NL39ss	M39	1 1/2"	40,4	58,5	6,8	25	6,74
NL42ss	M42		43,2	63,0	6,8	25	7,96
NL45ss	M45	1 3/4"	46,2	70,0	6,8	25	10,20
NL48ss	M48		49,6	75,0	6,8	25	12,00
NL52ss	M52	2"	53,6	80,0	9,0	1	20,10
NL56ss	M56	2 1/4"	59,1	85,0	9,0	1	21,30
NL60ss	M60		63,1	90,0	9,0	1	23,50
NL64ss	M64	2 1/2"	67,1	95,0	9,0	1	25,80
NL68ss	M68		71,1	100,0	9,0	1	28,20
NL72ss	M72		75,1	105,0	9,0	1	30,70
NL76ss	M76	3"	79,1	110,0	9,0	1	33,30
NL80ss	M80	3 1/8"	83,1	115,0	9,0	1	36,00

NL3ss – NL8ss
 $\phi_i \pm 0,1$ mm
 NL10ss – NL42ss
 $\phi_i \pm 0,2$ mm
 NL45ss – NL80ss
 $\phi_i +0,5 / -0,0$ mm

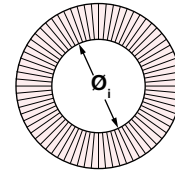

NL3ss – NL24ss
 $\phi_o \pm 0,2$ mm
 NL27ss – NL42ss
 $\phi_o \pm 0,3$ mm
 NL45ss – NL80ss
 $\phi_o +0,0 / -2,0$ mm

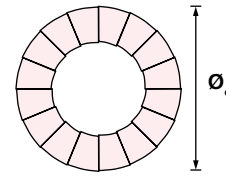

NL3ss – NL24ss
 $T \pm 0,25$ mm
 NL27ss – NL42ss
 $T +0,0 / -0,5$ mm
 NL45ss – NL80ss
 $T \pm 0,75$ mm

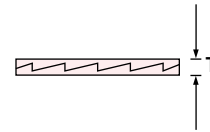

- Please consult our website for current dimensions and 2D / 3D CAD models: www.nord-lock.com/cad

Torque guidelines

Nord-Lock stainless steel washers with stainless steel bolt, lubricated with copper/graphite paste (Molykote® 1000).

Washer size	Bolt size	Pitch [mm]	A4-70, Cu/C paste, $G_f=65\%$, $\mu_{th}=0,12$, $\mu_b=0,14$		A4-80, Cu/C paste, $G_f=65\%$, $\mu_{th}=0,12$, $\mu_b=0,14$	
			Torque [Nm]	Clamp load [kN]	Torque [Nm]	Clamp load [kN]
NL3ss	M3	0,5	1,5	1,5	1,7	2,0
NL4ss	M4	0,7	3,0	2,6	3,6	3,4
NL5ss	M5	0,8	5,5	4,1	6,7	5,5
NL6ss	M6	1,0	8,1	5,9	11,2	7,8
NL8ss	M8	1,25	18	11	21	14
NL10ss	M10	1,5	26	17	34	23
NL12ss	M12	1,75	41	25	62	33
NL14ss	M14	2,0	68	34	101	45
NL16ss	M16	2,0	108	46	157	61
NL18ss	M18	2,5	157	56	224	75
NL20ss	M20	2,5	223	72	318	95
NL22ss	M22	2,5	310	89	438	118
NL24ss	M24	3,0	397	103	558	137
NL27ss	M27	3,0	589	134	823	179
NL30ss	M30	3,5	815	164	1132	219
NL36ss	M36	4,0	1445	239	1993	319

Cu/C paste = Copper/graphite paste (Molykote® 1000)

G_f = ratio of yield point

μ_{th} = thread friction

μ_b = washer friction

1 N = 0,225 lb

1 Nm = 0,738 ft-lb

Torque guidelines for other bolt grades are available through your local Nord-Lock representative.

Nord-Lock washers made of stainless steel are standard stock items, yet subject to prior sale.

Nord-Lock 254 SMO® washers

EN 1.4547 or equivalent, surface hardened

254 SMO® is a high performance austenitic stainless steel (according to EN 1.4547) with greater mechanical strength and resistance against corrosion than most austenitic stainless steel grades. The material is resilient against pitting and crevice corrosion due to high contents of chromium, nickel, molybdenum and nitrogen. Nord-Lock 254 SMO® washers are specially designed for chloride rich processes and salt water solutions / atmospheres, i.e. environments where stainless steel washers made of EN 1.4404 are not suitable.

Dimension chart

Washer size	Bolt size		ϕ_i [mm]	ϕ_o [mm]	Thickness T [mm]	Min. package [pairs]	Approx weight kg / 100 pairs
	Metric	UNC					
NL3ss-254	M3	#5	3,4	7,0	2,2	200	0,04
NL3,5ss-254	M3,5	#6	3,9	7,6	2,2	200	0,04
NL3,5spss-254	M3,5	#6	3,9	9,0	2,2	200	0,07
NL4ss-254	M4	#8	4,4	7,6	2,2	200	0,04
NL4spss-254	M4	#8	4,4	9,0	2,2	200	0,07
NL5ss-254	M5	#10	5,4	9,0	2,2	200	0,06
NL5spss-254	M5	#10	5,4	10,8	2,2	200	0,11
NL6ss-254	M6		6,5	10,8	2,2	200	0,09
NL6spss-254	M6		6,5	13,5	2,2	200	0,16
NL1/4"-254		1/4"	7,2	11,5	2,2	200	0,09
NL1/4"spss-254		1/4"	7,2	13,5	2,2	200	0,15
NL8ss-254	M8	5/16"	8,7	13,5	2,0	200	0,12
NL8spss-254	M8	5/16"	8,7	16,6	2,2	200	0,22
NL3/8"ss-254		3/8"	10,3	16,6	2,0	200	0,19
NL3/8"spss-254		3/8"	10,3	21,0	2,2	200	0,38
NL10ss-254	M10		10,7	16,6	2,0	200	0,18
NL10spss-254	M10		10,7	21,0	2,2	200	0,37
NL11ss-254	M11	7/16"	11,4	18,5	2,2	200	0,26
NL12ss-254	M12		13,0	19,5	2,0	200	0,23
NL12spss-254	M12		13,0	25,4	3,0	100	0,82
NL1/2"ss-254		1/2"	13,5	19,5	2,2	200	0,23
NL1/2"spss-254		1/2"	13,5	25,4	3,2	100	0,80
NL14ss-254	M14	9/16"	15,2	23,0	3,0	100	0,49
NL14spss-254	M14	9/16"	15,2	30,7	3,2	100	1,31
NL16ss-254	M16	5/8"	17,0	25,4	3,0	100	0,59
NL16spss-254	M16	5/8"	17,0	30,7	3,2	100	1,13
NL18ss-254	M18		19,5	29,0	3,2	100	0,80
NL18spss-254	M18		19,5	34,5	3,2	100	1,56
NL3/4"ss-254		3/4"	20,0	30,7	3,2	100	0,96
NL3/4"spss-254		3/4"	20,0	39,0	3,2	100	2,14
NL20ss-254	M20		21,4	30,7	3,0	100	0,82
NL20spss-254	M20		21,4	39,0	3,2	100	1,98
NL22ss-254	M22	7/8"	23,4	34,5	3,2	100	1,19
NL22spss-254	M22	7/8"	23,4	42,0	3,2	50	2,44
NL24ss-254	M24		25,3	39,0	3,2	100	1,65
NL24spss-254	M24		25,3	48,5	3,2	50	3,50
NL1"ss-254		1"	27,9	39,0	3,2	100	1,42
NL1"spss-254		1"	27,9	48,5	3,2	50	3,22
NL27ss-254	M27		28,4	42,0	5,8	50	3,10
NL27spss-254	M27		28,4	48,5	5,8	25	5,85
NL30ss-254	M30	1 1/8"	31,4	47,0	5,8	50	4,04
NL33ss-254	M33	1 1/4"	34,4	48,5	5,8	25	4,25
NL36ss-254	M36	1 3/8"	37,4	55,0	5,8	25	5,96
NL39ss-254	M39	1 1/2"	40,4	58,5	5,8	25	6,74

Nord-Lock washers made of 254 SMO® quality are standard stock items, yet subject to prior sale.

NL3ss-254
-NL8ss-254
 $\phi_i \pm 0,1$ mm
NL10ss-254
-NL39ss-254
 $\phi_i \pm 0,2$ mm

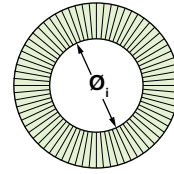

NL3ss254
-NL24ss-254
 $\phi_i \pm 0,2$ mm
NL27ss-254
-NL39ss-254
 $\phi_o \pm 0,3$ mm

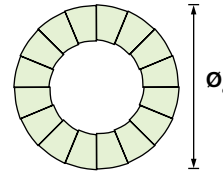

NL3ss-254
-NL39ss-254
T $\pm 0,25$ mm

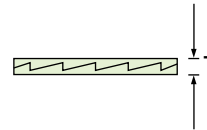

- Please consult our website for current dimensions and 2D / 3D CAD models: www.nord-lock.com/cad

Torque guidelines

Nord-Lock 254 SMO® washers with stainless steel bolt, lubricated with copper/graphite paste (Molykote® 1000).

Washer size	Bolt size	Pitch [mm]	A4-70, Cu/C paste, $G_f=65\%$, $\mu_{th}=0,12$, $\mu_b=0,14$		A4-80, Cu/C paste, $G_f=65\%$, $\mu_{th}=0,12$, $\mu_b=0,14$	
			Torque [Nm]	Clamp load [kN]	Torque [Nm]	Clamp load [kN]
NL3ss-254	M3	0,5	1,5	1,5	1,7	2,0
NL4ss-254	M4	0,7	3,0	2,6	3,6	3,4
NL5ss-254	M5	0,8	5,5	4,1	6,7	5,5
NL6ss-254	M6	1,0	8,1	5,9	11,2	7,8
NL8ss-254	M8	1,25	18	11	21	14
NL10ss-254	M10	1,5	26	17	34	23
NL12ss-254	M12	1,75	41	25	62	33
NL14ss-254	M14	2,0	68	34	101	45
NL16ss-254	M16	2,0	108	46	157	61
NL18ss-254	M18	2,5	157	56	224	75
NL20ss-254	M20	2,5	223	72	318	95
NL22ss-254	M22	2,5	310	89	438	118
NL24ss-254	M24	3,0	397	103	558	137
NL27ss-254	M27	3,0	589	134	823	179
NL30ss-254	M30	3,5	815	164	1132	219
NL36ss-254	M36	4,0	1445	239	1993	319

Cu/C paste = Copper/graphite paste (Molykote® 1000)

G_f = ratio of yield point

μ_{th} = thread friction

μ_b = washer friction

1 N = 0,225 lb

1 Nm = 0,738 ft-lb

Torque guidelines for other bolt grades are available through your local Nord-Lock representative.

Nord-Lock washers joint guide



Tapped holes

Nord-Lock washers safely lock the bolt against the underlying surface.



Counter bores

The outer diameter of regular Nord-Lock washers is designed for counter-bore holes according to DIN 974, i.e. the washers fit under the head of standard bolts.



Through holes

As for all locking washers, through holes require two pairs of Nord-Lock washers – one pair for securing the bolt and a second pair for securing the nut.

Turn both fasteners in order to close the cams on both washer pairs before tightening to minimize settlements. Keep the nut secure whilst tightening the bolt.



Stud bolts

Nord-Lock washers safely lock the nut on stud bolts and eliminate the need for adhesives.



Large / slotted holes



Soft underlying surfaces

Applications with large / slotted holes or soft underlying surfaces

To optimize the load distribution for applications with large / slotted holes or with soft underlying surface, use a flanged nut / bolt together with Nord-Lock "SP" washers with enlarged outer diameter.



Designs where Nord-Lock washers are not recommended

- Mating surfaces that are not locked in place (see left figure)
- Mating surfaces harder than the washers
- Very soft mating surface, e.g. wood, plastic
- Applications with extremely large settlements
- Non-preloaded joints

If your application corresponds to one or more of the mentioned design criteria, contact your Nord-Lock representative and we will help you find an alternative solution.

Nord-Lock "sp" (enlarged outer diameter) washers

Nord-Lock washers are available with an enlarged outer diameter, referred to as "sp" washers. "sp" washers are designed for use on large / slotted holes, painted / sensitive surfaces or soft materials. Use Nord-Lock "sp" washers with flanged bolts or nuts for optimum load distribution.

\varnothing inner regular = \varnothing inner "sp"
 \varnothing outer regular < \varnothing outer "sp"

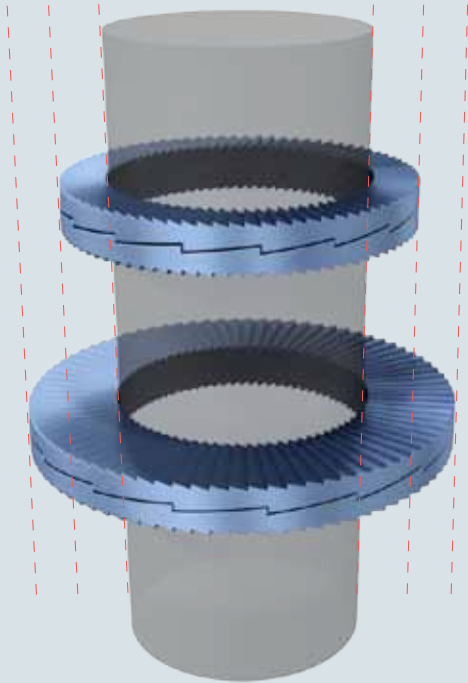

A flanged nut and Nord-Lock "sp" washers increase the load supporting surface for applications with slotted holes.

By using "sp" washers, the load is distributed over a larger surface which can be more gentle for sensitive surfaces. Please consult Nord-Lock to find the optimal solution for your application.

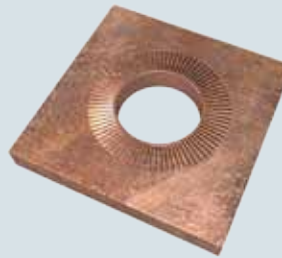

Nord-Lock "sp" washers on soft metal.

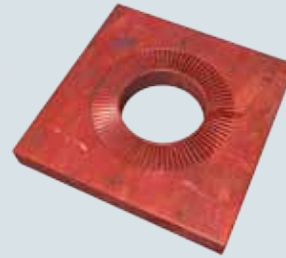

Nord-Lock "sp" washers on painted surface.

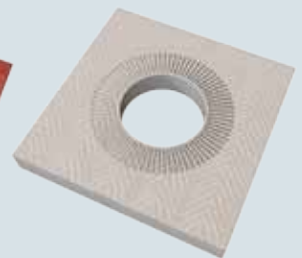

Nord-Lock "sp" washers on fibre surface.

Uniform friction with Nord-Lock washers

It is important to have control over the friction conditions in order to obtain the desired preload when tightening a joint.

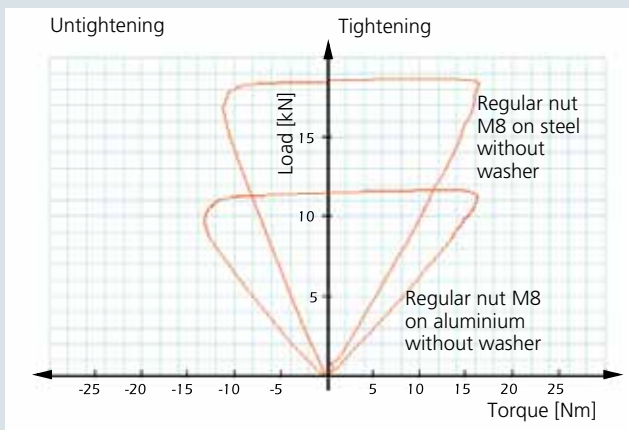

When no washer is used under the fastener, the friction depends on the contact surface. At a given torque, the obtained preload will vary depending on the contact material.

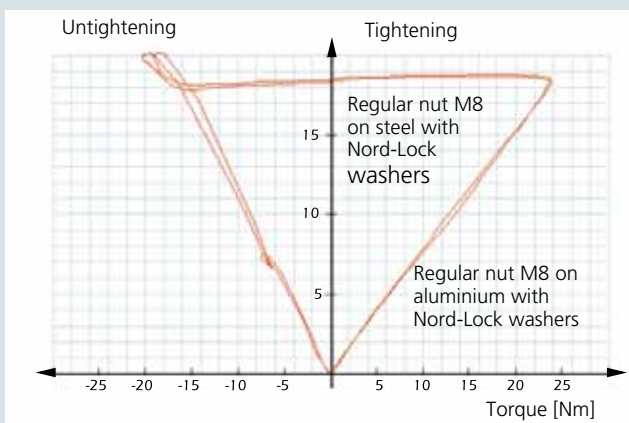

When using Nord-Lock washers, sliding always occurs between the upper washer and the bolt head / nut. At a given torque, the preload will be the same, regardless of the contact material.

Nord-Lock provides customized torque guidelines for your application, contact your nearest representative.

Your partner in bolt securing



The Nord-Lock Group offers continuous support; from design phase, testing and verification, through installation and maintenance. We continually develop our products and unique solutions and use state-of-the-art bolt securing technology. We also know that a good product is not enough. At Nord-Lock we share our experience, knowledge and creativity to help our clients achieve the outstanding results they require. Let Nord-Lock be your partner in bolt optimization.

Customer unique solutions

Over the years, The Nord-Lock Group has entered several partnerships to develop unique solutions for the most creative designs. Should you find that the products presented in this brochure do not meet your requirements – let us help you find the optimum solution.



The Nord-Lock Group product portfolio includes a wide range of products and we are continuously developing new innovative solutions. Contact us to learn more about our current range.

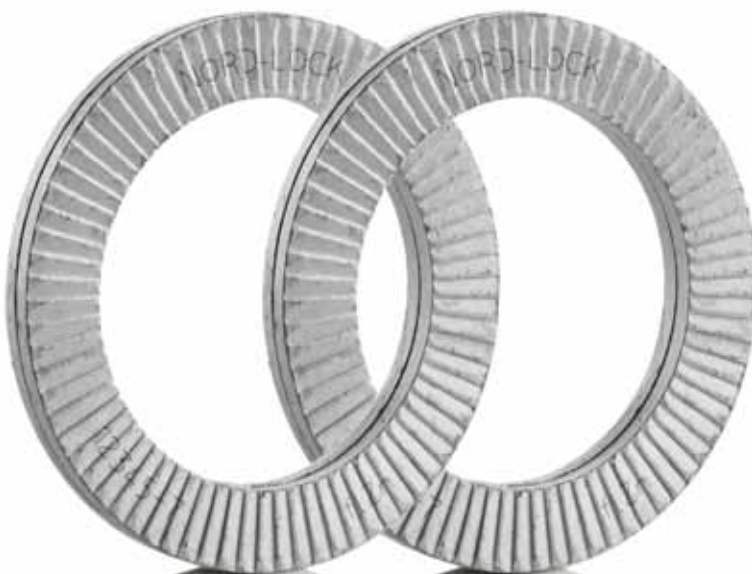



Performance Services

Nord-Lock Performance Services is a partnership project offered to key customers. The purpose is to increase profitability by generating a complete and detailed view of the design of bolted connections and securing methods. As each project is designed to meet customer specific needs and challenges, both current applications and future designs can be investigated. In addition, our global chain of services supports you throughout sourcing, design / production and aftermarket.

Presence in your market

The Nord-Lock Group includes subsidiaries, in-house laboratories on three continents, and a worldwide network of authorized distributors. In addition, our Global Industry Managers with specialist skills are trained to understand the specific needs and challenges in your industry. Our philosophy is to be close to our customers, to speak your language and to help you achieve secure and effective bolted joints. To find the complete list of Nord-Lock representatives, please go to www.nord-lock.com/contact



Nord-Lock global chain of services

Sourcing
Life Cycle Profitability and cost justification

Cost savings generated by optimized bolted joints.

Design / Production
Field Application Engineer, Technical Centers & Project Engineering

Joint calculation and simulation. Real life testing and validation. Custom designs.

Aftermarket
On-site and remote product training as well as service and retrofitting

Increasing the knowledge for operators and engineers. Installation support.

When **safety** really matters



Joining parts together is one of the most critical steps when delivering a product or system. The Nord-Lock Group is focused on solving the toughest bolting challenges. We offer a unique combination of bolting expertise and a wide product range, including wedge-locking technology and Superbolt tensioners — all designed and developed in-house.

Nord-Lock holds decades of documented success in every major industry, including oil and gas, energy, transportation and mining. Our Production System includes rigorous internal testing and full traceability, and our products hold several certificates from independent institutes including AbP, ABS, DIBt, DNV and TÜV.

The tools available through Nord-Lock Performance Services add value throughout a project and ensure that your bolting application pays back multiple times. We can also assist you in the design phase with joint simulation and testing. Additionally, we help you ensure successful operations over time with our onsite support and remote product training.

Our mission is to safeguard human lives and customer investments by securing the world's most demanding applications. The Nord-Lock Group looks forward to being your partner in bolting solutions.

Authorized distributor:

© Copyright 2012-2013 Nord-Lock International AB. NORD-LOCK is a trademark owned by Nord-Lock International AB or its affiliates. All other logos, trademarks, registered trademarks or service marks used herein are the property of Nord-Lock International AB and its affiliates or licensors. No part of this document may be reproduced or transmitted in any form or by any means, electronic, mechanical, photocopying, recording, or otherwise, without prior written permission of Nord-Lock. All rights reserved.